

Current Transformer AC/DC TRMS Loop Powered 2000.35.013

The 2000.35.013 is a AC/DC current transformer, galvanically isolated from the measuring circuit. The device is in the function and appearance very similar to a standard active TA, however, able to measure the DC component and AC TRMS (True RMS). The transformer is powered 4-20mA current loop and therefore does not require a direct power supply. It 's the first Hall's effect current transformer loop-powered with **0.5% accuracy** on the market.

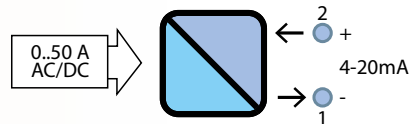
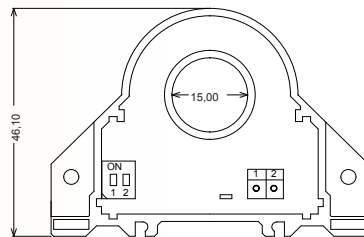
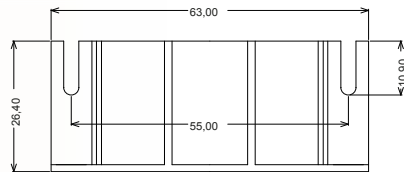

POWER SUPPLY Passive loop powered, 11 .. 30V, Protections against polarity reversal and overtemperature.

ABSORPTION Less then 3,5mA

PROTECTION INDEX IP20

ACCURACY 0,5% F.S.

RESOLUTION 12 bit

TEMPERATURE COEFFICIENT < 200 ppm/°C

WORKING TEMPERATURE -15 .. +65°

STORAGE TEMPERATURE -40°C .. +85°C

RESPONSE TIME 1000 ms

TYPE OF MEASURE TRMS (True RMS)

RANGE 50 Arms or 25 Arms dip-switch setting, bipolar (+/- 50A DC o +/-25A DC)

OUTPUT 4 .. 20 mA

BAND WIDTH AT -3dB DC or 20 .. 2000 Hz

ISOLATION 3kV on bare wire

OVERLOAD 2k A pulse, 300 A continuous

CREST FACTOR 2

HYSTERESIS 0,15% f.s.

HUMIDITY 10 .. 90% not condensing

ALTITUDE Up to 2000 m s.l.m.

WEIGHT 72 gr

FILLING Epoxy Resins

BOX MATERIAL PBT, gray

MOUNTING Screw predisposition for vertical / horizontal mounting, DIN Rail clips (included) for vertical / horizontal mounting

TERMINAL Removable terminals 5,08mm

DIP-SWITCH 2 poles

LED N°1 yellow (Power on)

STANDARDS CE EN61000-6-4/2007-01; EN64000-6-2/2006-10; EN61010-1/2001

DIMENSIONS 46,1x 63x 26,4 mm (terminal excluded)

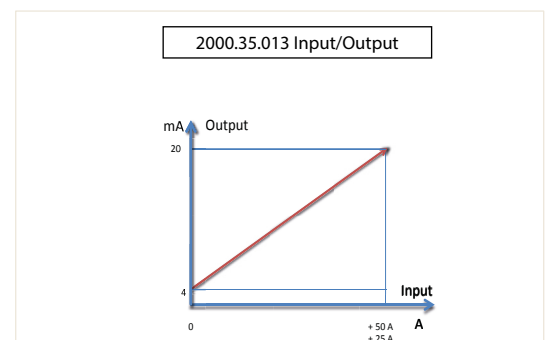
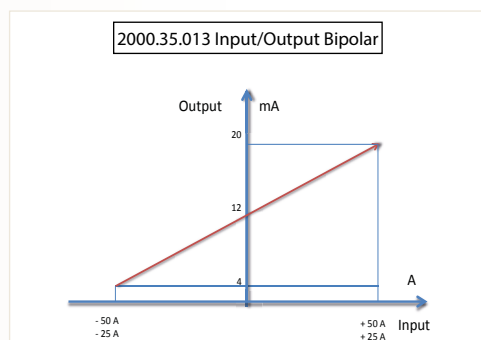

Current Transformer AC/DC TRMS Loop Powered 2000.35.013

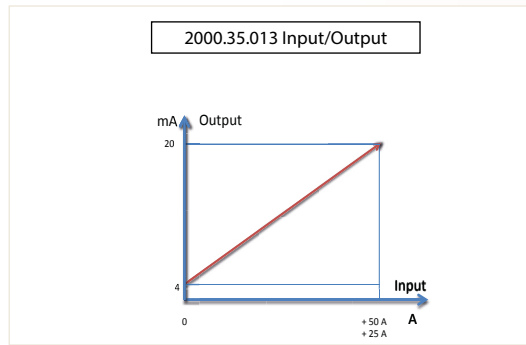
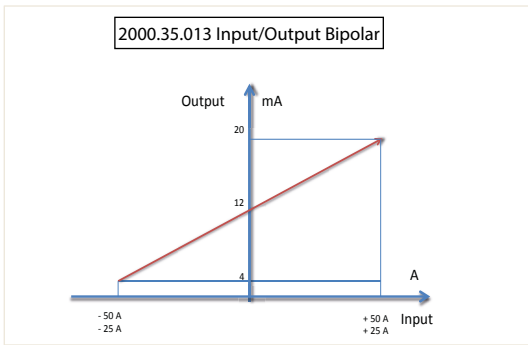

The 2000.35.013 has two dip-switches through which you can set the scale to 25 or 50A and select the monopolar or bipolar (see charts), the yellow led near the terminal will indicate the presence of the power supply.

Any changes made by dip-switch required to switch off the power supply. It's a safety condition in order to prevent any manumission on the device.

Dip-Switch table:

DESCRIPTION	1	2
MONOPOLAR (TRMS)		0
BIPOLAR (MEAN VALUE)		1
50 A	0	
25 A	1	

CAUTION: magnetic fields of high intensity can vary the values measured by the transformer. Avoid installation near permanent magnets, electromagnets or iron masses that induce strong changes in the magnetic field. If any irregularity recommend reorient or move the transformer in the area most appropriate.

MOUNTING:

The current transformer 2000.35.013 can be mounted in any position (see photo below), horizontal or vertical mounting, horizontal or vertical through the two hooks for DIN rail included in the box.

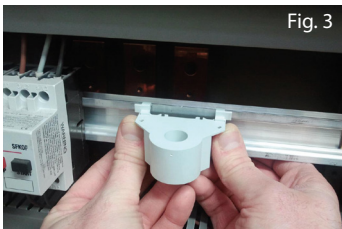

DIN RAIL MOUNTING INSTRUCTIONS:
 To mount the hooks on 2000.35.013. If you want to mount horizontally, use the flexibility of hook to catch into prepared by pressing the center of the clip (fig. 1).

For vertical mounting, slide the hooks into the slots, external holding the two tabs on the clip (fig. 2).

For mounting on DIN rail horizontally, once hooked on the bottom, push with both hands as shown in fig. 3.

For vertical mounting on DIN rail, once hooked on the bottom, push with both hands on the hooks as shown in fig. 4.

To release from DIN rail, use a screwdriver and lever up to release the fins (fig. 5 or fig. 6).

Trasformatore di Corrente AC/DC TRMS Loop Powered 2000.35.013

Il **2000.35.013** è un trasformatore di corrente continua ed alternata, galvanicamente isolato dal circuito di misura. Il dispositivo è nella funzione e nell'aspetto del tutto simile ad un TA attivo standard, in grado però di misurare la componente continua e alternata **TRMS** (True RMS). Il trasformatore è alimentato in loop di corrente 4-20mA e quindi non necessita di una alimentazione diretta. È il primo trasformatore ad effetto di Hall loop-powered con **precisione 0,5 %** presente sul mercato.

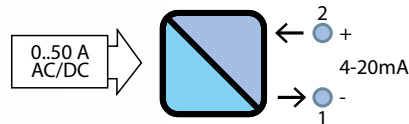
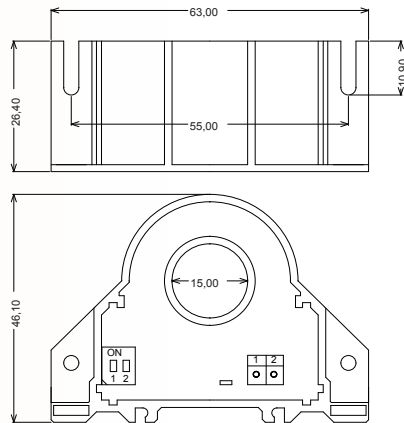

ALIMENTAZIONE Loop passivo di corrente, 11 .. 30Vdc, Protezioni per inversione polarità e sovra temperatura.

ASSORBIMENTO Minore di 3,5mA

GRADO DI PROTEZIONE IP20

CLASSE DI PRECISIONE 0,5% F.S.

RISOLUZIONE 12 bit

COEFFICIENTE TEMPERATURA < 200 ppm/°C

TEMPERATURA DI LAVORO -15 .. +65°

TEMPERATURA DI STOCCAGGIO -40°C .. +85°C

VELOCITÀ DI RISPOSTA 1000 ms

TIPO DI MISURA TRMS (True RMS)

PORTATE 50 Arms o 25 Arms impostabili da dip-switch, bipolare (+/- 50A DC o +/-25A DC)

USCITA 4 .. 20 mA

BANDA PASSANTE a -3dB DC oppure 20 .. 2000 Hz

ISOLAMENTO 3kV su cavo nudo

SOVRACCARICO 2k A impulsivi, 300 continuativi

FATTORE DI CRESTA 2

ISTERESI SULLA MISURA 0,15% f.s.

UMIDITÀ 10 .. 90% non condensante

ALTITUDINE Fino a 2000 m s.l.m.

PESO 72 gr

RIEMPIMENTO Resina epossidica

INVOLUCRO PBT

SISTEMA DI AGGANCIAMENTO Predisposizione per aggancio verticale/orizzontale con viti, predisposizione per aggancio verticale/orizzontale per barra DIN (clip incluse)

CONNESSIONI Morsetto estraibile passo 5,08mm

DIP-SWITCH 2 poli

LED N°1 giallo, per segnalazione Power-on

NORMATIVA CE EN61000-6-4/2007-01; EN64000-6-2/2006-10; EN61010-1/2001

DIMENSIONI 46,1x 63x 26,4 mm (escluso morsetto)

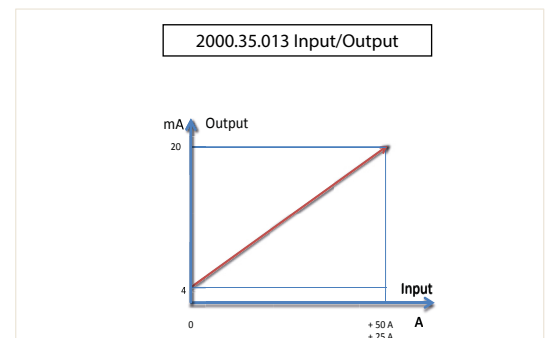
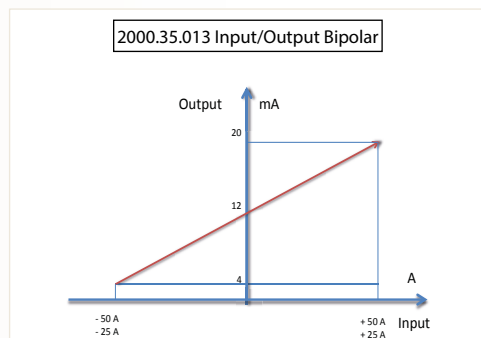

Trasformatore di Corrente AC/DC TRMS Loop Powered 2000.35.013

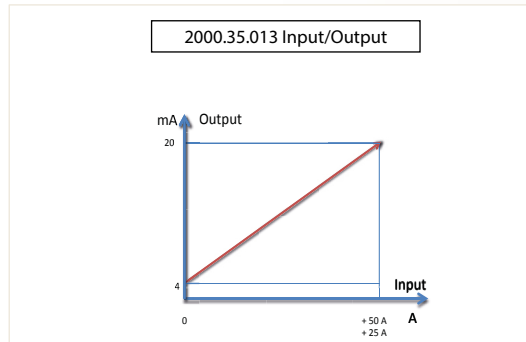
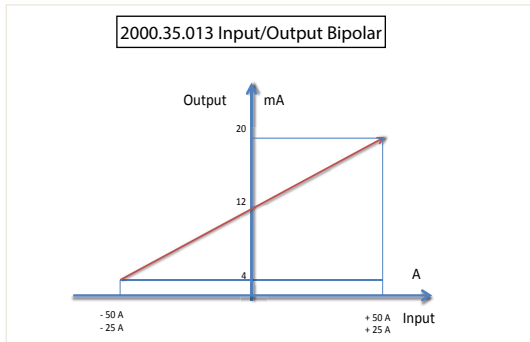

Il 2000.35.013 presenta due dip-switch attraverso i quali potete impostare il fondo scala a 25 o 50A e selezionare la funzione monopolare o bipolare (vedi grafici), il led giallo posto vicino alla morsettiera vi indica la presenza dell'alimentazione

Tabella dip-switch:

DESCRIZIONE	1	2
MONOPOLARE (TRMS)		0
BIPOLARE (VALORE MEDIO)		1
50 A	0	
25 A	1	

MONTAGGIO:

Il trasformatore di corrente 2000.35.013 può essere montato in qualsiasi posizione (vedere foto in basso), orizzontale o verticale con viti, orizzontale o verticale attraverso i due gancetti per barra din inclusi nella scatola.

ATTENZIONE: campi magnetici di notevole intensità possono far variare i valori misurati dal trasformatore. Evitare l'installazione vicino a magneti permanenti, elettromagneti o masse ferrose che inducano forti alterazioni del campo magnetico. Qualora si manifestassero anomalie consigliamo di orientare diversamente il trasformatore o spostarlo in zona più consona.

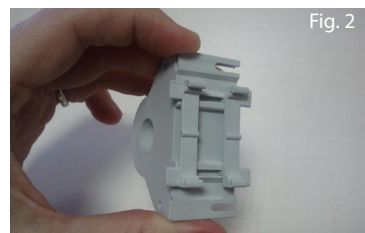

Prima montare i gancetti sul 2000.35.013.

Se si vuole montare in orizzontale, sfruttare la flessibilità del gancetto per agganciarlo nell'alloggiamento predisposto facendo pressione al centro del gancetto (fig.1).

Per il montaggio in verticale, far scivolare i gancetti nelle guide, tendendo esterne le due alette del gancetto (fig.2).

Per l'aggancio su barra din in orizzontale, una volta agganciato sulla parte inferiore, fare pressione con entrambe le mani come in fig.3.

Per il montaggio in verticale su barra din, una volta agganciato sulla parte inferiore, fare pressione con entrambe le mani sui gancetti come in fig.4

Per lo sgancio da barra din, utilizzare un cacciavite facendo leva sulle alette fino allo sgancio (fig.5 o fig.6).

Transformador de Corriente AC/DC TRMS Loop Powered 2000.35.013

El **2000.35.013** es un transformador de corriente continua y alterna, galvanicamente aislado del circuito de medida. El dispositivo ofrece la función y el aspecto del todo similar a un TA activo standard, en grado también de medir la componente continua y alterna **TRMS** (True RMS). El transformadore está alimentado en loop de corriente 4-20mA así que no necesita de una alimentación directa. ES el primer transformador a efecto de Hall loop-powered con **precisión 0,5 %** presente en el mercado.

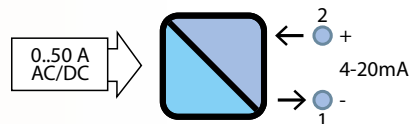
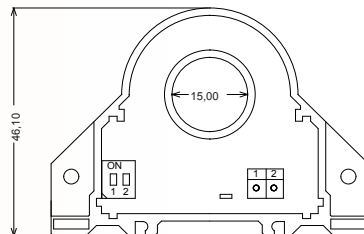
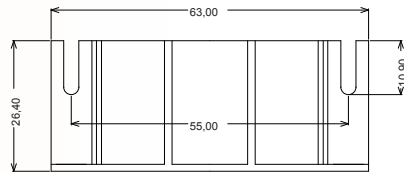

ALIMENTACION Loop pasivo de corriente, 11 .. 30Vdc, Protecciones para inversión polaridad y sobre temperatura.

ABSORCION Menor de 3,5mA

GRADO DE PROTECCION IP20

CLASE DE PRECISION 0,5% F.S.

RESOLUCION 12 bit

COEFICIENTE TEMPERATURA < 200 ppm/°C

TEMPERATURA DE TRABAJO -15 .. +65°

TEMPERATURA DE ALMACENAJE -40°C .. +85°C

VELOCIDAD DE RESPUESTA 1000 ms

TIPO DE MEDIDA TRMS (True RMS)

RANGOS 50 Arms o 25 Arms configurables desde dip-switch, bipolar (+/- 50A DC o +/-25A DC)

SALIDA 4 .. 20 mA

BANDA PASANTE a -3dB DC o 20 .. 2000 Hz

AISLAMIENTO 3kV en cable desnudo

SOBRECARGA 2k A impulsivos, 300 continuativos

FACTOR DE CRESTA 2

HISTERESIS EN LA MEDIDA 0,15% f.s.

HUMEDAD 10 .. 90% no condensante

ALTITUD Hasta 2000 m s.l.m.

PESO 72 gr

LLENADO Resina epoxídica

ENVOLTURA PBT

SISTEMA DE ENGANCHE Predisposición para el enganche vertical/horizontal con tornillos, predisposición para el enganche vertical/horizontal para riel DIN (clips incluidos)

CONEXIONES Borne extraíble paso 5,08mm

DIP-SWITCH 2 polos

LED N°1 amarillo, para señalización Power-on

NORMATIVA CE EN61000-6-4/2007-01; EN64000-6-2/2006-10; EN61010-1/2001

DIMENSIONES 46,1x 63x 26,4 mm (borne excluido)

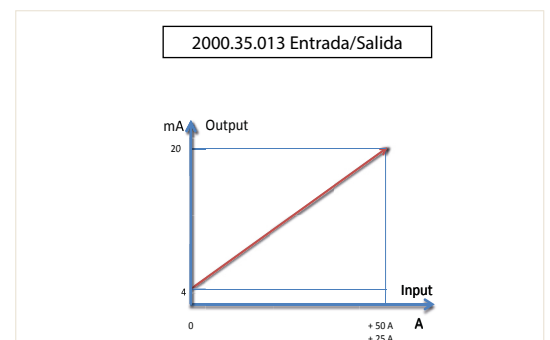
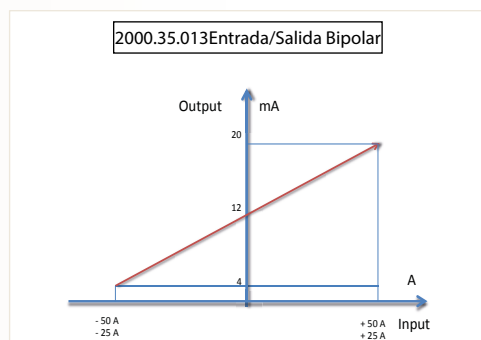

Transformador de Corriente AC/DC TRMS Loop Powered 2000.35.013

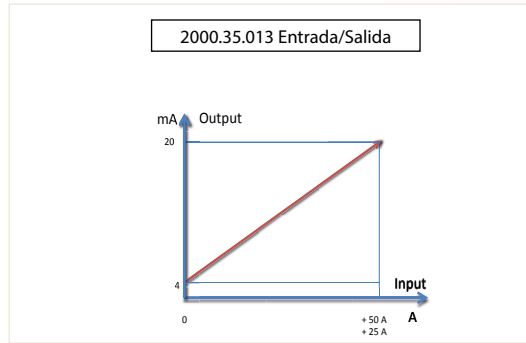
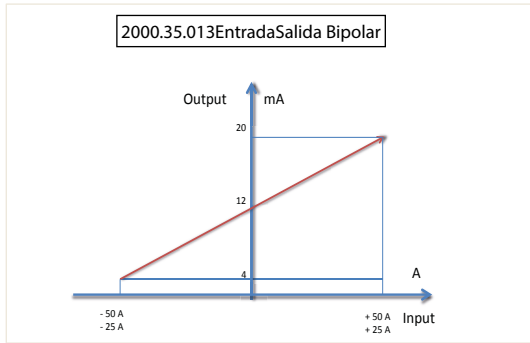

El 2000.35.013 presenta dos dip-switch a través el cual se puede configurar el fondoescala a 25 o 50A e seleccionar la función monopolar o bipolar (ver gráficos) , el led amarillo colocado cerca a la bornera indica la presencia de la alimentación

Tabla dip-switch:

DESCRIPCION	1	2
MONOPOLAR (TRMS)		0
BIPOLAR (VALOR MEDIO)		1
50 A	0	
25 A	1	

ATENCIÓN: campos magnéticos de gran intensidad pueden hacer variar los valores medidos del transformador. Evitar la instalación cerca a magnetos permanentes, electromagnetos o masas ferrosas que induzcan fuertes alteraciones del campo magnético. En el caso se manifiesten anomalías aconsejamos orientar en forma diferente el transformador o cambiarlo de zona.

MONTAJE:

El transformador de corriente 2000.35.013 puede ser montado en cualquier posición (ver foto inferior), horizontal o vertical con tornillos, horizontal o vertical a través de dos ganchos para riel din incluidos en la caja.

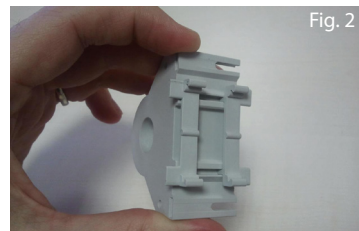

Primero montar los ganchos en el 2000.35.013.

Si se quiere montar en horizontal, aprovechar la flexibilidad del gancho para agancharlo en el sitio predispuesto haciendo presión al centro del gancho (fig.1).

Para el montaje en vertical, hacer deslizar los ganchos en las guías, teniendo externas las dos alas del gancho (fig.2).

Para el enganche en riel din en horizontal, una vez enganchado en la parte inferior, hacer presión con ambas manos como en fig.3.

Para el montaje en vertical en riel din, una vez enganchado en la parte inferior, hacer presión con ambas manos en los ganchos como en fig.4

Para el desenganche del riel din, usar un destornillador haciendo palanca sobre las alas hasta desenganchar (fig.5 ó fig.6).