

CNV510-PBUS-RTU-A

Software version SW67561

Profibus Slave / Modbus Master Converter



User Manual



WARNING:

Pixsys srl reserves the right to change information in this manual about our product without warning. Pixsys srl is not responsible for any error this manual may contain.

TRADEMARKS:

All trademarks mentioned in this document belong to their respective owners.

SECURITY ALERT:

GENERAL INFORMATION

To ensure safe operation, the device must be operated according to the instructions in the manual. When using the device, legal and safety regulation are required for each individual application. The same applies also when using accessories.

INTENDED USE

Machines and systems must be designed so the faulty conditions do not lead to a dangerous situation for the operator (i.e. independent limit switches, mechanical interlocks, etc.).

QUALIFIED PERSONNEL

The device can be used only by qualified personnel, strictly in accordance with the specifications.

Qualified personnel are persons who are familiar with the installation, assembly, commissioning and operation of this equipment and who have appropriate qualifications for their job.

RESIDUAL RISKS

The device is state-of-the-art and is safe. The instruments can represent a potential hazard if they are inappropriately installed and operated by untrained personnel. These instructions refer to residual risks with the following symbol:



This symbol indicates that non-observance of the safety instructions is a danger for people that could lead to serious injury or death and / or the possibility of damage.

CE CONFORMITY

The declaration is made by our company. You can send an email to support@pixsys.net or give us a call if you need it.



CHARACTERISTICS:

The CNV510-PBUS-RTU-A is a PROFIBUS Slave → Modbus Master Converter.

It allows the following characteristics:

- Up to 512 bytes in reading and 512 bytes in writing;
- Triple isolation between Modbus - Power Supply, Modbus - Ethernet, Power Supply – Ethernet;
- Two-directional information between Modbus bus and PROFIBUS bus;
- Mountable on 35mm Rail DIN;
- Wide power supply input range: 8..19V AC or 8..35V DC (Maximum consumption at 24V: 4 W / VA);
- Wide environment conditions: 0..45°C, humidity 35..95 uR%;
- Serials Protocols supported:
 - o Simple ASCII Protocol;
 - o Simple Binary Protocol;
 - o Modbus;
 - o JBUS.

CONFIGURATION:

You need Software **SW67561** on your PC in order to perform the following:

- Define the parameter of the Profibus line;
- Define the parameter of the Modbus line;
- Define the data to Read in Modbus and where to map these information in the Profibus array;
- Define the data to Write in Modbus and where to take the information in the Profibus array;
- Update the device.

MECHANICAL DIMENSIONS:

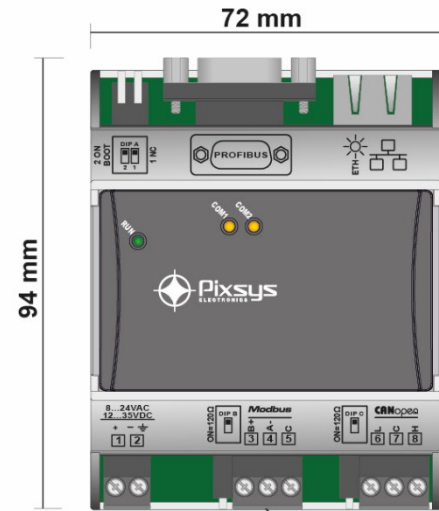

Morsettiere Estraibili
Extractable terminal blocks

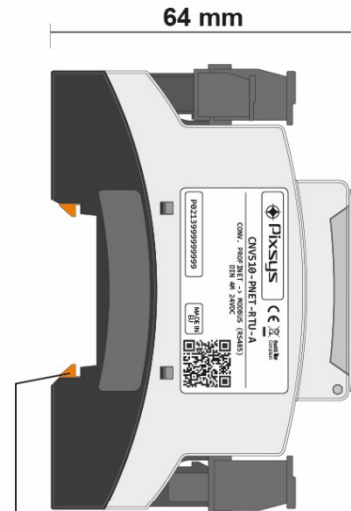

Attacco a guida DIN EN50022
Din rail mounting guide EN50022



EXAMPLE OF CONNECTION:

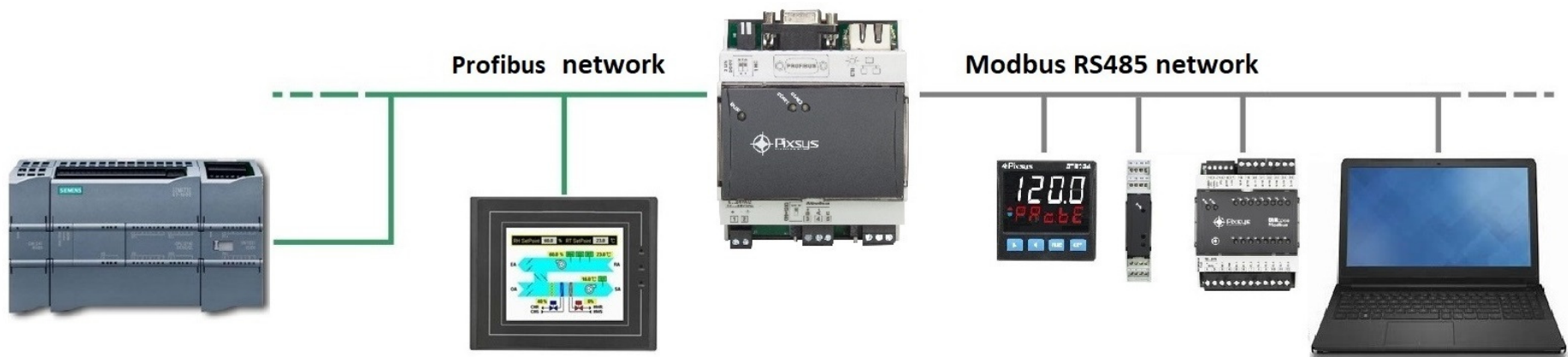

CONNECTION SCHEME:

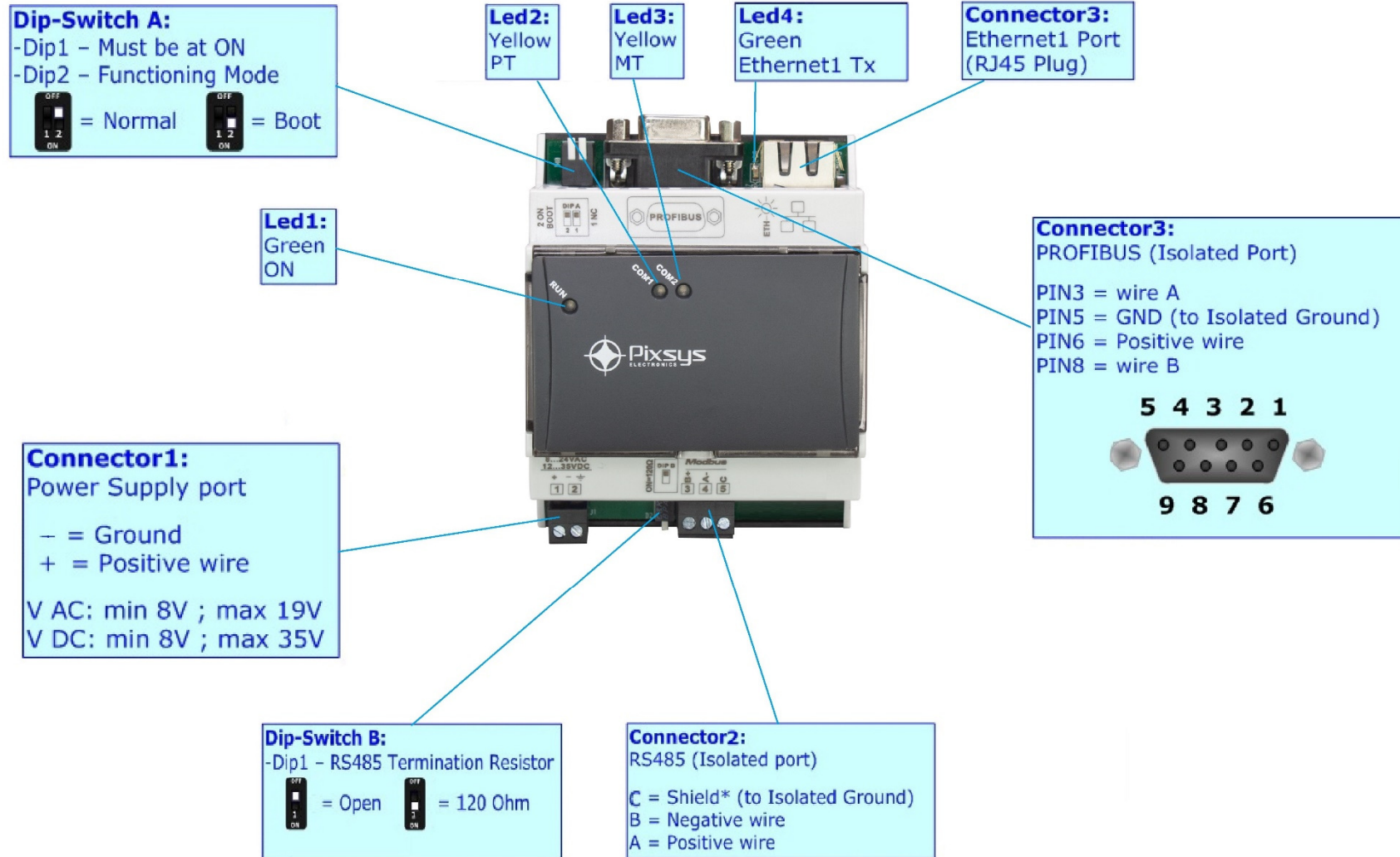

POWER SUPPLY:

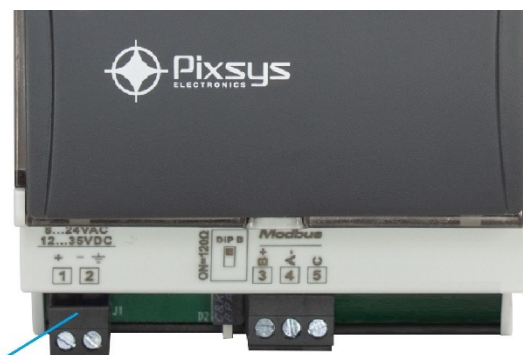

Connector1:
Power Supply port
- = Ground
+ = Positive wire
V AC: min 8V ; max 19V
V DC: min 8V ; max 35V

FUNCTION MODES:

The device has got two functions mode depending of the position of the 'Dip2 of Dip-Switch A':

- The first, with 'Dip2 of Dip-Switch A' at "OFF" position, is used for the normal working of the device.
- The second, with 'Dip2 of Dip-Switch A' at "ON" position, is used for upload the Project and/or Firmware.

For the operations to follow for the updating, see 'UPDATE DEVICE' section.

According to the functioning mode, the LEDs will have specifics functions, see 'LEDS' section.

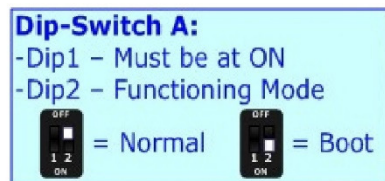

Warning:

Dip1 of 'Dip-Switch A' must be always at ON position!

LEDS:

LEDs that are used to give information of the functioning status.
The various meanings of the LEDs are described in the table below.

LED	Normal Mode	Boot Mode
1: ON [supply voltage] (green)	ON: Device powered OFF: Device not powered	ON: Device powered OFF: Device not powered
2: PT [Profibus state] (yellow)	FLASHING: Profibus transmissions present OFF: No Profibus transmissions present	OFF
3: MT [Modbus state] (yellow)	FLASHING: MODBUS-RTU transmissions present OFF: No MODBUS-RTU transmissions present	OFF
4: Ethernet1 Tx (green)	Blinks when is transmitting Ethernet frames	Blinks quickly: Boot state Blinks very slowly (~0.5Hz): Update in progress
Internal LED (green)	Blinks very slowly (~0.5Hz): Device is working in normal mode	

PROFIBUS:

The PROFIBUS uses a 9-pin D-SUB connector. The pin assignment is defined like in the right figure.

Here some codes of cables:

- Belden: p/n 183079A - Continuous Armor DataBus® ISA/SP-50 PROFIBUS Cable.

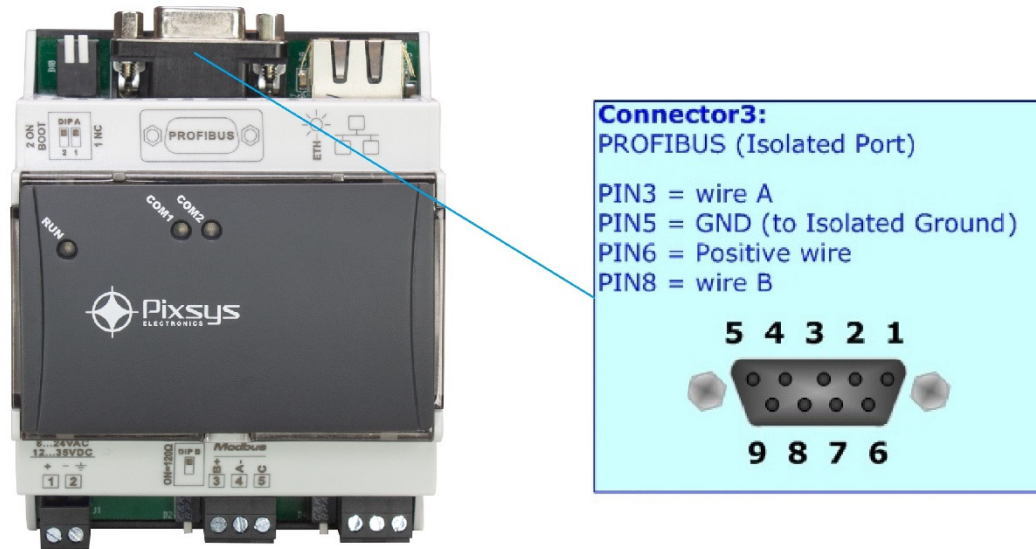

RS485:

For terminate the RS485 line with a 120Ω resistor it is necessary to put ON dip 2, like in figure. The maximum length of the cable should be 1200m (4000 feet).

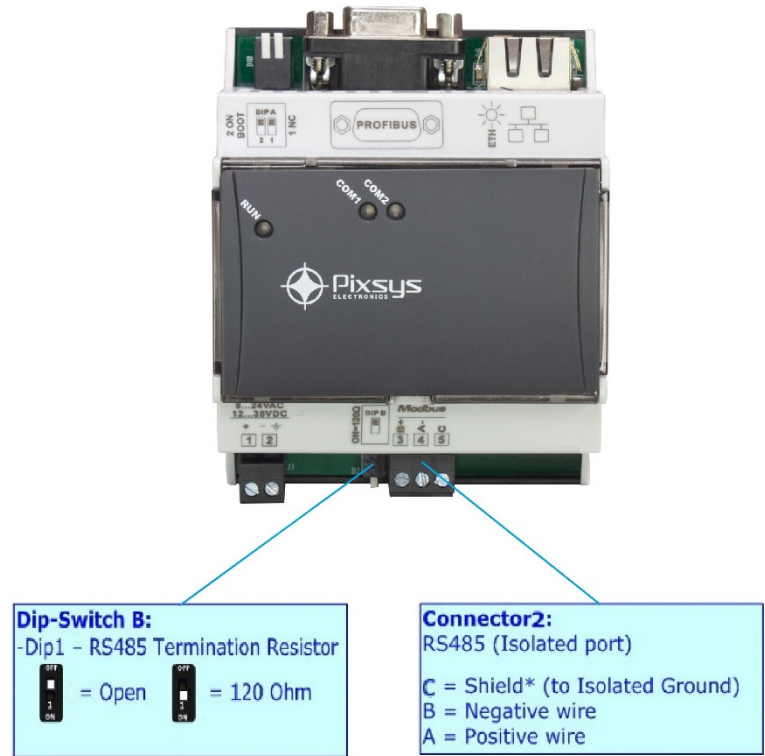

Here some codes of cables:

- Belden: p/n 8132 - 2x 28AWG stranded twisted pairs conductor + foil shield + braid shield;
- Belden p/n 82842 - 2x 24AWG stranded twisted pairs conductor + foil shield + braid shield;
- Tasker: p/n C521 - 1x 24AWG twisted pair conductor + foil shield + braid shield;
- Tasker: p/n C522 - 2x 24AWG twisted pairs conductor + foil shield + braid shield.

USE OF CONFIGURATION SOFTWARE SW67561:

To configure the Converter, use the available software that runs with Windows called SW67561. It is downloadable on the Pixsys download are (<https://cloud.pixsys.net/>) and its operation is described in this document. (*This manual is referenced to the last version of the software present on our web site*). The software works only on Microsoft Windows (XP, Vista, Seven, 8, 10; 32/64bit architectures).

When launching the SW67561, the window below appears (Fig. 2).

 **Note:**
It is necessary to have installed .Net Framework 4.

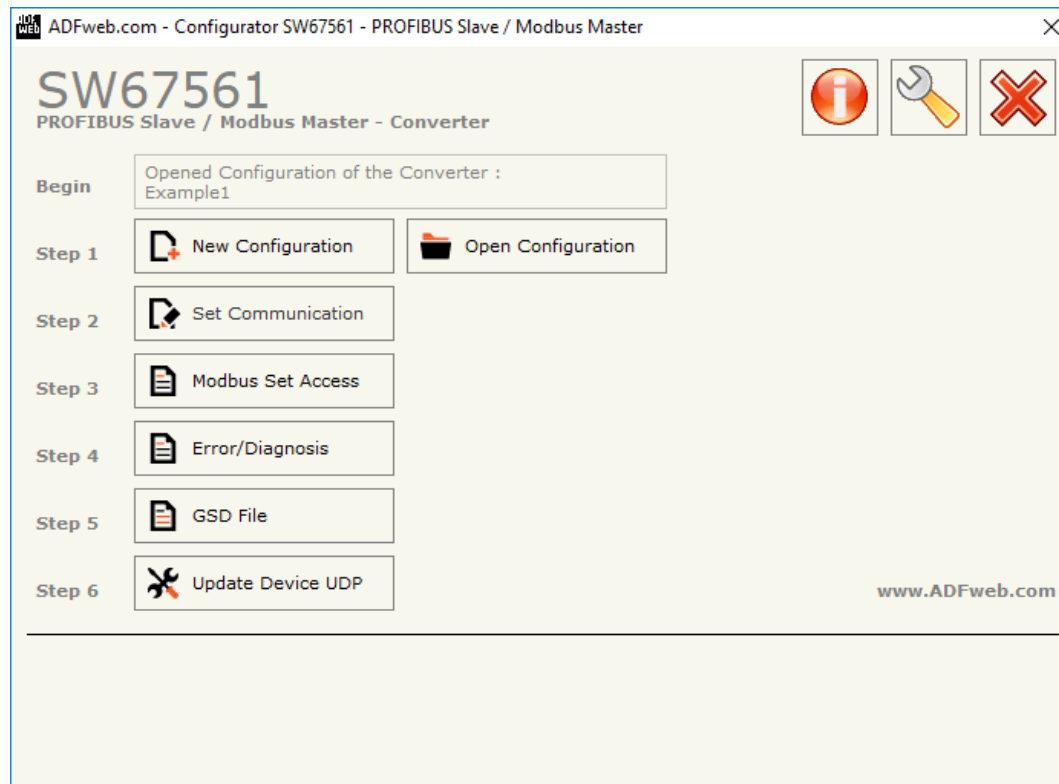
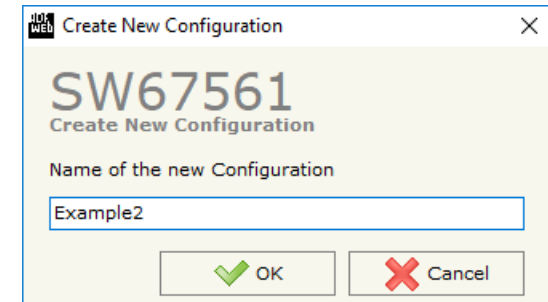

Figure 2: Main window for SW67561

NEW CONFIGURATION / OPEN CONFIGURATION:

The **"New Configuration"** button creates the folder which contains the entire device's configuration.



A device's configuration can also be imported or exported:

- To clone the configurations of a Programmable "Profibus Slave / Modbus Master - Converter" in order to configure another device in the same manner, it is necessary to maintain the folder and all its contents;
- To clone a project in order to obtain a different version of the project, it is sufficient to duplicate the project folder with another name and open the new folder with the button **"Open Configuration"**.

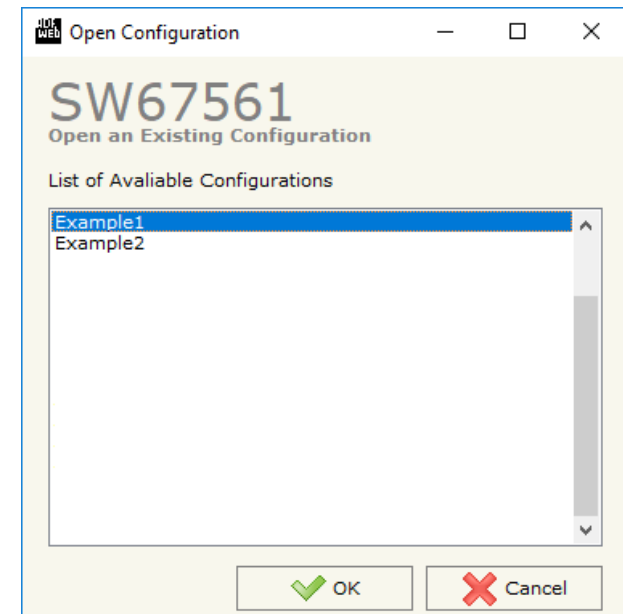



SOFTWARE OPTIONS:

By pressing the “Settings” () button there is the possibility to change the language and check the updatings of the software.

In the section “Language” it is possible to change the language of the software.

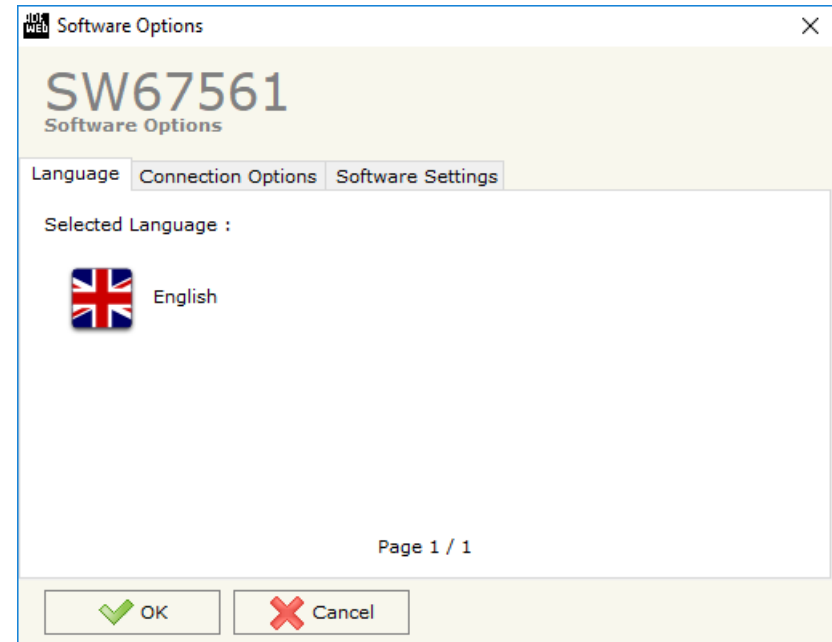
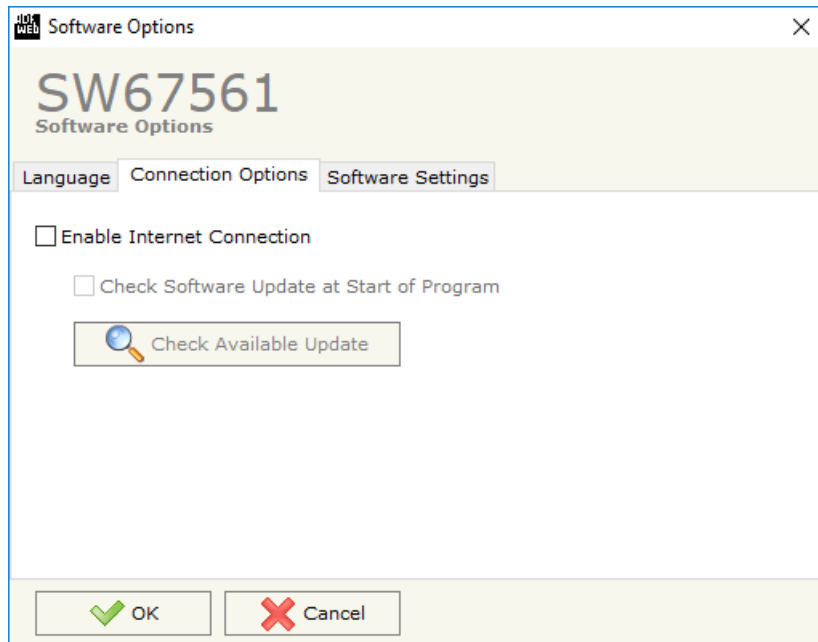

In the section “Connection Options”, it is possible to check if there are some updatings of the software in Pixsys srl website.

Checking the option “**Check Software Update at Start of Program**”, the SW67607 checks automatically if there are updatings when it is launched.

SET COMMUNICATION:

This section defines the fundamental communication parameter of two buses, Serial and PROFIBUS.

By Pressing the **“Set Communication”** button from the main window of SW67561 (Fig. 2) the window **“Set Communication”** appears (Fig. 3).

The Window is divided in three sections, one for the hardware type, one for the Modbus Master and the other for PROFIBUS.

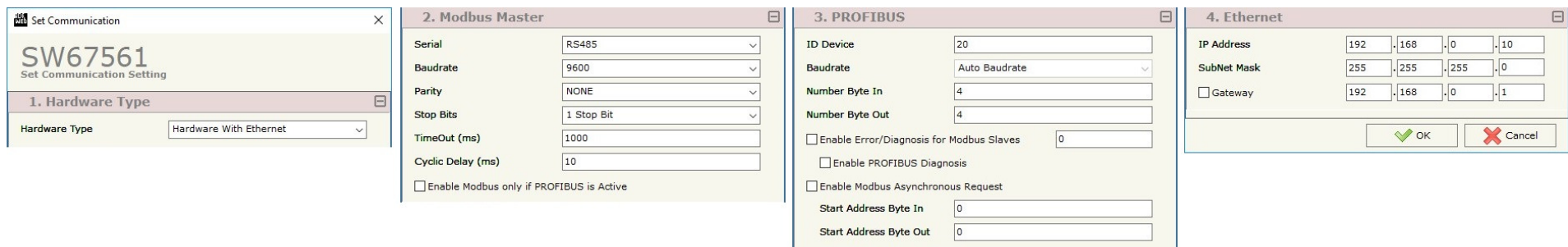

The screenshot shows the 'Set Communication' window for SW67561, divided into four sections:

- 1. Hardware Type:** Hardware Type is set to 'Hardware With Ethernet'.
- 2. Modbus Master:**
 - Serial: RS485
 - Baudrate: 9600
 - Parity: NONE
 - Stop Bits: 1 Stop Bit
 - TimeOut (ms): 1000
 - Cyclic Delay (ms): 10
 - Enable Modbus only if PROFIBUS is Active
- 3. PROFIBUS:**
 - ID Device: 20
 - Baudrate: Auto Baudrate
 - Number Byte In: 4
 - Number Byte Out: 4
 - Enable Error/Diagnosis for Modbus Slaves (0)
 - Enable PROFIBUS Diagnosis
 - Enable Modbus Asynchronous Request
 - Start Address Byte In: 0
 - Start Address Byte Out: 0
- 4. Ethernet:**
 - IP Address: 192.168.0.10
 - SubNet Mask: 255.255.255.0
 - Gateway: 192.168.0.1

Buttons: OK, Cancel

In the **“Hardware Type”** sections, please select **“Hardware With Ethernet”**.

The means of the fields for "Modbus Master" are:

- In the field "**Serial**" is possible to select the serial line used for Modbus. Please select "RS485";
- In the field "**Baudrate**" please define the baudrate for the serial line;
- In the field "**Parity**" please select the parity of the serial line;
- In the field "**Stop Bits**" please select the Stop Bits of the RS485;
- In the field "**TimeOut (ms)**" insert the maximum time that the converter attends for the answer from the slave interrogated (1000ms is the default value);
- In the field "**Cyclic Delay (ms)**" insert the delay between two requests (10mS is the default value);
- If the field "**Enable Modbus only if PROFIBUS is Active**" is checked, the converter do the Modbus requests only if PROFIBUS connection is established; otherwise the requests are made also if PROFIBUS is not operational. (disabled is is the default value);

The means of the fields for "PROFIBUS" are:

- In the field "**ID Device**" insert the address of the PROFIBUS side;
- In the field "**Baudrate**" the baudrate for the PROFIBUS is defined, please leave it as AUTO;
- In the field "**Number Byte IN**" the number of byte from the slave PROFIBUS to the converter is defined;
- In the field "**Number Byte OUT**" the number of byte from the converter to the slave PROFIBUS is defined.
- If the field "**Enable Error/Diagnosis for Modbus Slaves**" is checked, the converter can advice a problem with one or more devices in Modbus network. In the field on right is necessary to insert the start byte address of array OUT where is saved the Diagnosis;
- If the field "**Enable PROFIBUS Diagosis**" is checked, the converter use the Diagnosis to show an error of one or more Modbus device. (The "Enable Error/Diagnosis for Modbus Slaves" must be selected for enable this option);
- If the field "**Enable Modbus Asynchronous Requests**" is checked, is possible to send a Modbus Request using some bytes of the PROFIBUS to controll the requests;
- In the field "**Start Address Byte IN**" the starting address where the gateway send to the PROFIBUS master the state of Modbus request (for more info see the chapter "Async Remote Request"). Remember, there are 4 bytes of state of the modbus request;
- In the field "**Start Address Byte OUT**" the starting address where the PROFIBUS master send to the gateway the parameters of the Modbus Request (for more info see the chapter "Async Remote Request"). Remember, there are 8 bytes of parameters for the modbus request.

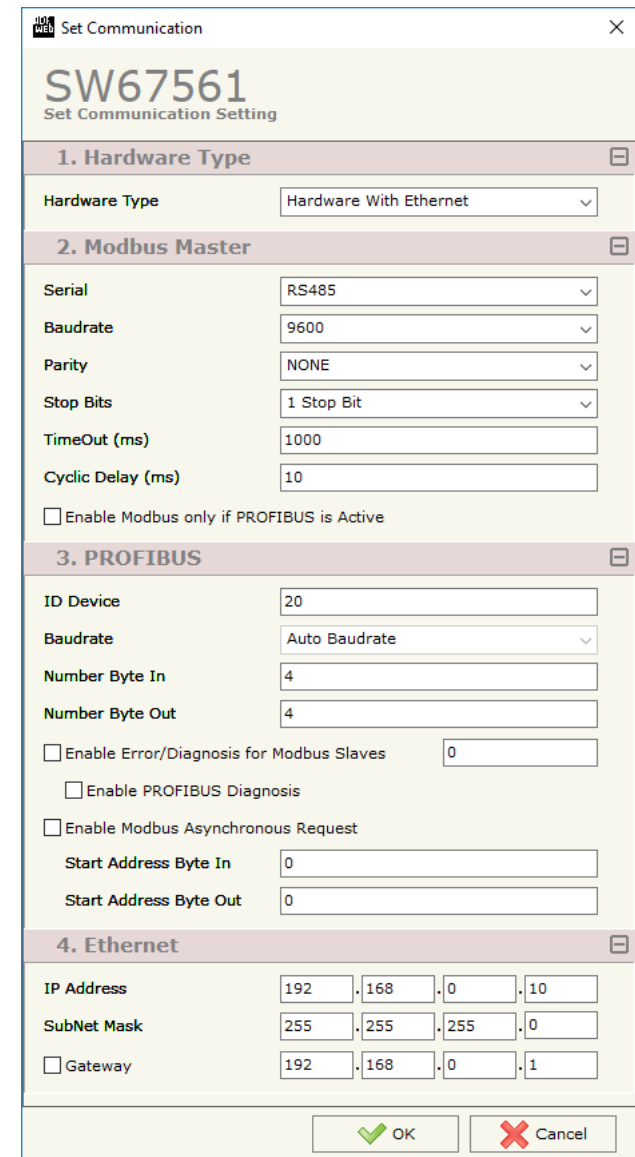

SW67561
Set Communication Setting

1. Hardware Type

Hardware Type: Hardware With Ethernet

2. Modbus Master

Serial: RS485
 Baudrate: 9600
 Parity: NONE
 Stop Bits: 1 Stop Bit
 TimeOut (ms): 1000
 Cyclic Delay (ms): 10

Enable Modbus only if PROFIBUS is Active

3. PROFIBUS

ID Device: 20
 Baudrate: Auto Baudrate
 Number Byte In: 4
 Number Byte Out: 4

Enable Error/Diagnosis for Modbus Slaves (Start Address Byte Out: 0)
 Enable PROFIBUS Diagnosis
 Enable Modbus Asynchronous Request

Start Address Byte In: 0
 Start Address Byte Out: 0

4. Ethernet

IP Address: 192 . 168 . 0 . 10
 SubNet Mask: 255 . 255 . 255 . 0
 Gateway: 192 . 168 . 0 . 1

OK Cancel



The meaning of the fields of "Ethernet" are:

- In the field "**IP Address**" please insert the IP address to assign to the converter;
- In the field "**SubNet Mask**" please insert the SubNet Mask of the converter;
- In the field "**Gateway**" the default gateway of the network is defined. This feature can be enabled or disabled pressing the Check Box field. This feature is used for going out of the net.

MODBUS SET ACCESS (for Hardware with Ethernet):

By pressing the "**Modbus Set Access**" button from the main window for SW67561 (Fig. 2) the window "Set Modbus Access" appears.

This window is divided in two parts, the "PROFIBUS In --> Serial Read" (Fig. 6) and the "Serial Write --> PROFIBUS Out" (Fig. 7).

The first part ("PROFIBUS IN --> Serial Read") is used to read the data that arrived from the Slave PROFIBUS.

The second part ("Serial Write --> PROFIBUS OUT") is used to write the data that will be sent to the Slave PROFIBUS.

PROFIBUS IN → Serial Read

The means of the fields are:

- In the field **"Slave ID"** the address of the Modbus device you have to read is defined;
- In the field **"Type"** insert the data type of the Register you would like to read. You can choose between **"Coil Status"**, **"Input Status"**, **"Holding Register"** and **"Input Register"**.
- In the field **"Address"** the start address of the register to be read is defined;
- In the field **"NPoint"** insert the number of consecutive registers to be read;
- In the field **"Poll Time"** insert the cyclic time to make this request;
- In the field **"Max Error"** the number of consecutive errors that the Master waits before discarding the row from the cycle of requests is defined;
- In the field **"Position"** the address for the PROFIBUS array is defined;
- The field **"Start Bit"** is used for the **"Coil and Input Status"** and it allows to select which bit of the selected Position using;
- If the field **"SWAP"** is checked, the data read is swapped;
- In the field **"Mnemonic"** the description for the request is defined.

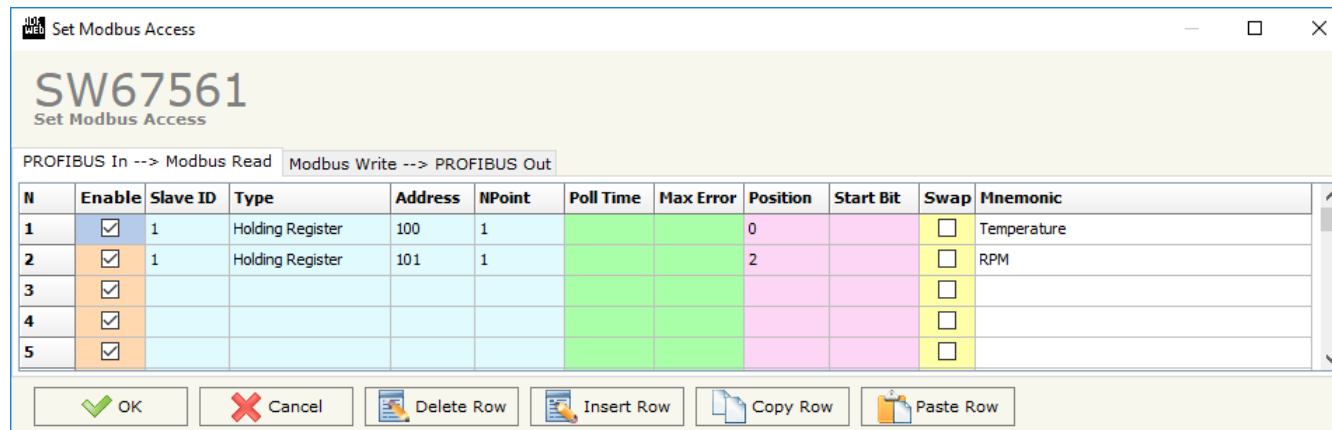

N	Enable	Slave ID	Type	Address	NPoint	Poll Time	Max Error	Position	Start Bit	Swap	Mnemonic
1	<input checked="" type="checkbox"/>	1	Holding Register	100	1			0		<input type="checkbox"/>	Temperature
2	<input checked="" type="checkbox"/>	1	Holding Register	101	1			2		<input type="checkbox"/>	RPM
3	<input checked="" type="checkbox"/>									<input type="checkbox"/>	
4	<input checked="" type="checkbox"/>									<input type="checkbox"/>	
5	<input checked="" type="checkbox"/>									<input type="checkbox"/>	

Figure 6: "Set Modbus Access / PROFIBUS In --> Serial Read" window

Serial Write → PROFIBUS OUT

The means of the fields are:

- In the field “**Slave ID**” the address of the Modbus device that you must write is defined;
- In the field “**Type**” insert the data type of the Register you would like to write. You can choose between “Coil Status” and “Holding Register”.
- In the field “**Address**” the start address of the register to be written is defined;
- In the field “**NPoint**” insert the number of consecutive registers to be written;
- In the field “**Poll Time**” insert the cyclic time to make this request;
- If the field “**On Change**” is checked, the Modbus writing request is made only if PROFIBUS data are changed; otherwise it is sent cyclically, using the “Poll Time”;
- In the field “**Max Error**” the number of consecutive errors that the Master waits before discarding the row from the cycle of requests is defined;
- In the field “**Position**” the address for the PROFIBUS array is defined;
- The field “**Start Bit**” is used for the “Coil Status” and it allows to select which bit of the selected Position using;
- If the field “**SWAP**” is checked, the data written is swapped
- In the field “**Mnemonic**” the description for the request is defined.

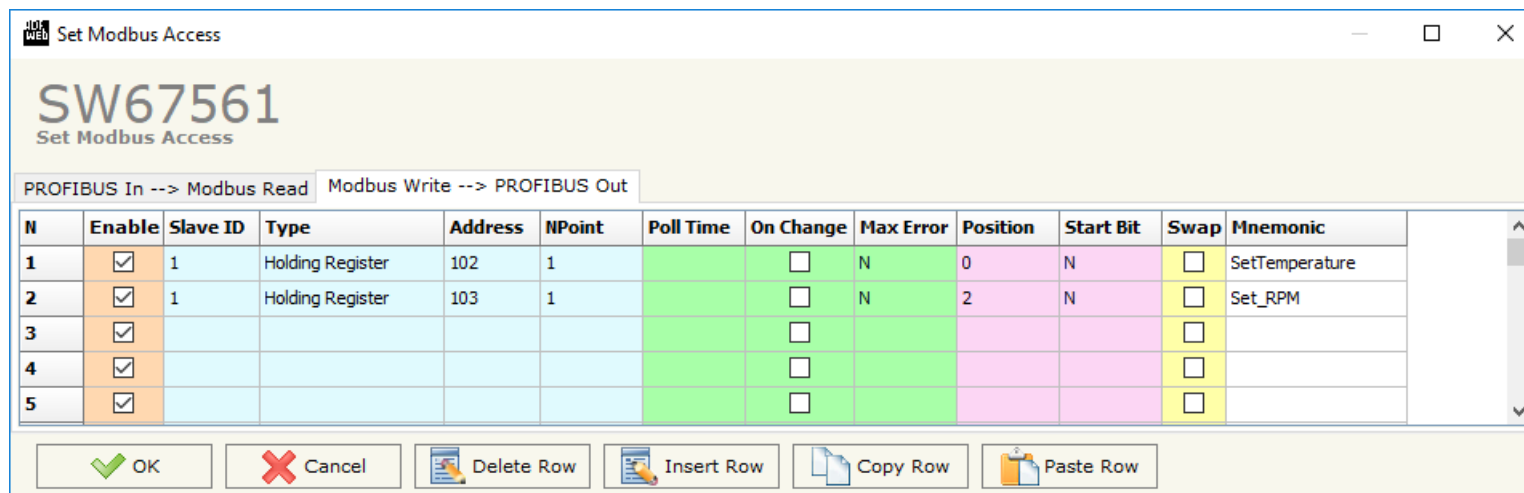

Figure 7: "Set Modbus Access / Modbus Write --> PROFIBUS Out" window

ERROR/DIAGNOSIS

By pressing the “**Error/Diagnosis**” button from the main window for SW67561 (Fig. 2) the window “Error/Diagnosis” appears.

In this window is possible to insert all the Modbus devices checked by the converter.

The table give the position of the bit that are set if the device is in error in the Diagnosis array in PROFIBUS.

The Diagnosis has always 6 byte fixed, then if there is some problem with some Modbus devices it increase the number of byte.

If there a problem in Modbus side, after the first 6 byte, there is a byte with a fix part (0x40) plus the number of follow bytes plus 1. For example if you want to monitor 10 Modbus devices you fond the first byte to the value 0x43 followed from 2 other byte that contain the status of each devices. If the bit is to 1 there is a problem on it device. Each byte can contain at maximum 8 Modbus devices.

For enable this feature you have to checked the “Enable check Modbus Error” option in the Set Communication section.

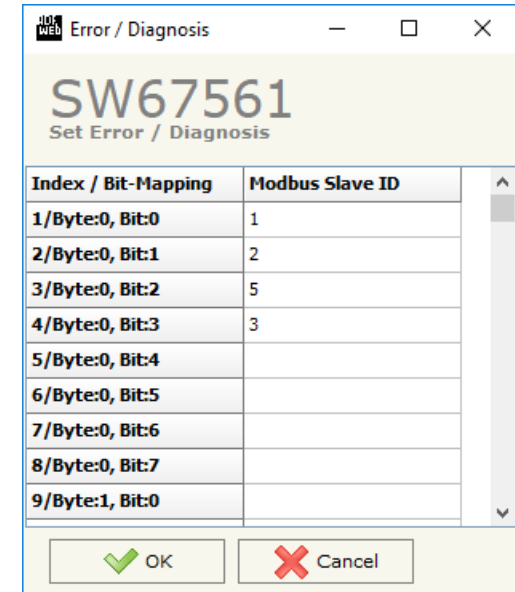

GSD FILE:

By pressing the “**GSD File**” button it is possible to save the GSD file for the PROFIBUS side.

With this feature you can save the configuration of the gateway of the PROFIBUS side.



Note:

When you import the .gsd file on your Master PROFIBUS you have to add all the modules that are present inside it.



ASYNCHRONOUS MODBUS REQUEST:

With the Async Modbus Request it is possible to send an Asynchronous Modbus Request from the PROFIBUS to the Modbus network.

To use this feature there are 8 bytes in write where the master PROFIBUS can send the parameters of the request and 4 bytes in read where the result of the Modbus communication is saved.

The parameters in write are:

BYTE	NAME	DESCRIPTION
1	Control_TX	It is the Control byte used to send the request
2	Spare	Not used/ Reserved
3	ID_Device	The ID of the Modbus Slave where to send the request
4	Function_Code	The Function Code of the request
5, 6	Address	Address of the Status/Register to read/write
7, 8	W_Value	Value to write (only if it is a Write request)

The Status in Read are:

BYTE	NAME	DESCRIPTION
1	Control_RX	It is the Control Byte used to send the status of the request modbus
2	Status_Request	It is the result of the Modbus request
3, 4	R_Value	Read value (only if it is a Read request)

The permitted values for the "Function Code" are:

- 1 → Read one Coil Status
- 2 → Read one Input Status
- 3 → Read one Holding Register
- 4 → Read one Input Register
- 5 → Write one Coil Status
- 6 → Write one Holding Register
- 15 → Write one Coil Status
- 16 → Write one Holding Register

The permits values for the "Status_Request" are:

- 0 → Performing Request
- 1 → Answer OK
- 2 → Answer with Exception
- 3 → Wrong Answer (CRC)
- 4 → Answer not Arrived (TimeOut Error)
- 5 → Wrong Request

Step to follow to send a Async Modbus Request

1. Check the value of the "Control_RX" byte. It must be 1 to accept a new Asynchronous request.
2. Insert the values of the request in "ID_Device", "Function_Code", "Address" and "W_Value" (if needed).
3. Put the "Control_TX" byte to 1 (it is necessary to leave this byte to 1 till the end of the request).
4. The "Control_RX" byte pass to the value 2, that mean the Converter waiting an answer from the Modbus Salve.
5. The "Control_RX" byte pass to the value 3, the request command is finish. In the "Status_Request" is possible to read the result of the request and in the R_Value the value of the Status/Register is saved (if it is a Read request)
6. When you read the answer you can put the "Control_TX" byte to 0 and the "Control_RX" byte will pass to 1 (now is possible to do a new Request).



Note:

When write a Coil Status using the Function Code 5 the admitted value in the W_Value are 0xFF00 for set the Status, 0x0000 for clear the Status.



Note:

When write a Coil Status using the Function Code 15 the admitted value in the W_Value are 0x0100 for set the Status, 0x0000 for clear the Status.



Note:

When read a Status the value will be available in the high part of the "R_Value". The admitted value are 0x01 or 0x00.



Note:

When the request exit with an exception (Status_Request == 2) is possible to read the Exception code in the high part of the "R_Value"

UPDATE VIA UDP:

By pressing the “**Update Device**” button, it is possible to load the created Configuration into the device; and also the Firmware, if necessary.

If you don’t know the actual IP address of the device, please follow this procedure:

- Turn OFF the Device;
- Put Dip2 of ‘Dip-Switch A’ in ON position;
- Turn ON the device
- Connect the Ethernet cable;
- Insert the IP “**192.168.2.205**”;
- Select which operations you want to do;
- Press the “**Execute update firmware**” button to start the upload;
- When all the operations are “OK” turn OFF the Device;
- Put Dip2 of ‘Dip-Switch A’ in OFF position;
- Turn ON the device.

At this point the configuration/firmware on the device is correctly updated.

If you know the actual IP address of the device, please follow this procedure:

- Turn on the Device with the Ethernet cable inserted;
- Insert the actual IP of the Converter;
- Select which operations you want to do;
- Press the “**Execute update firmware**” button to start the upload;
- When all the operations are “OK” the device automatically goes at Normal Mode.

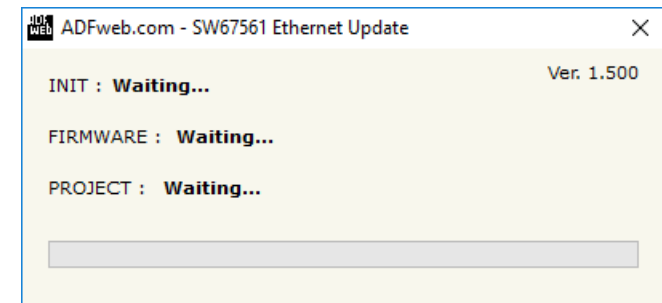
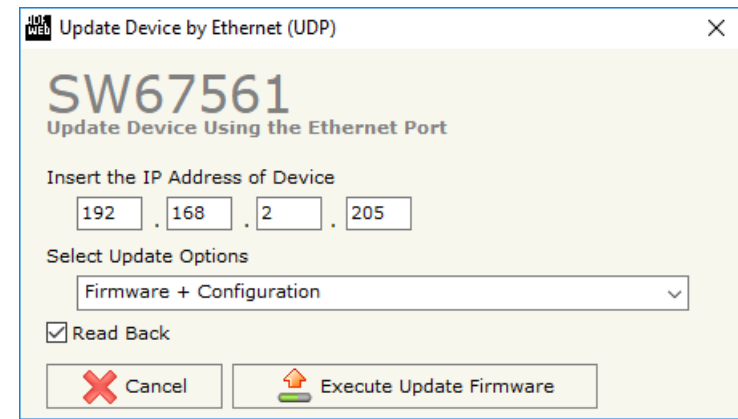

Figure 10: “Update via UDP” windows



Note:

When you install a new version of the software, if it is the first time it is better to do the update of the Firmware in the CNV510-PBUS-RTU device.



Note:

When you receive the device, for the first time, you also have to update the Firmware in the CNV510-PBUS-RTU device.



Warning:

If the Fig. 11 appears when you try to do the update try these points:

- Try to repeat the operations for the updating;
- Try with another PC;
- Try to restart the PC;
- If you are using the program inside a Virtual Machine, try to use in the main Operating System;
- If you are using Windows Seven or Vista or 8/10, make sure that you have the administrator privileges;
- Take attention at Firewall lock;
- Check the LAN settings.
- Check the Wi-Fi settings;
- If you are using the program inside a Virtual Machine, try to use in the main Operating System;
- If you are using Windows Seven, Vista, 8 or 10 make sure that you have the administrator privileges;
- In case you have to program more than one device, using the "*UDP Update*", you have to cancel the ARP table every time you connect a new device on Ethernet. For do this you have to launch the "Command Prompt" and write the command "*arp -d*". Pay attention that with Windows Vista, Seven, 8 you have to launch the "Command Prompt" with Administrator Rights;

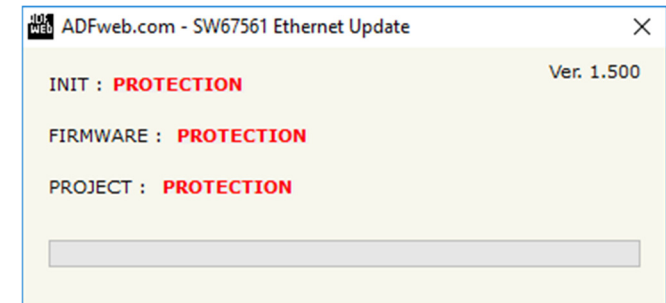



Figure 11: "Protection" window

PLC CONFIGURATION:

The configuration and commissioning of the CNV510-PBUS-RTU-A as described on the following pages was accomplished with the help of the TIA Portal V11-software by Siemens. In the case of using a control system from another supplier, refer to attend to the associated documentation.

 **Note:** Please follow the steps below in the exact order they are described!

- 1) Install the description file **.GSD** of the module.

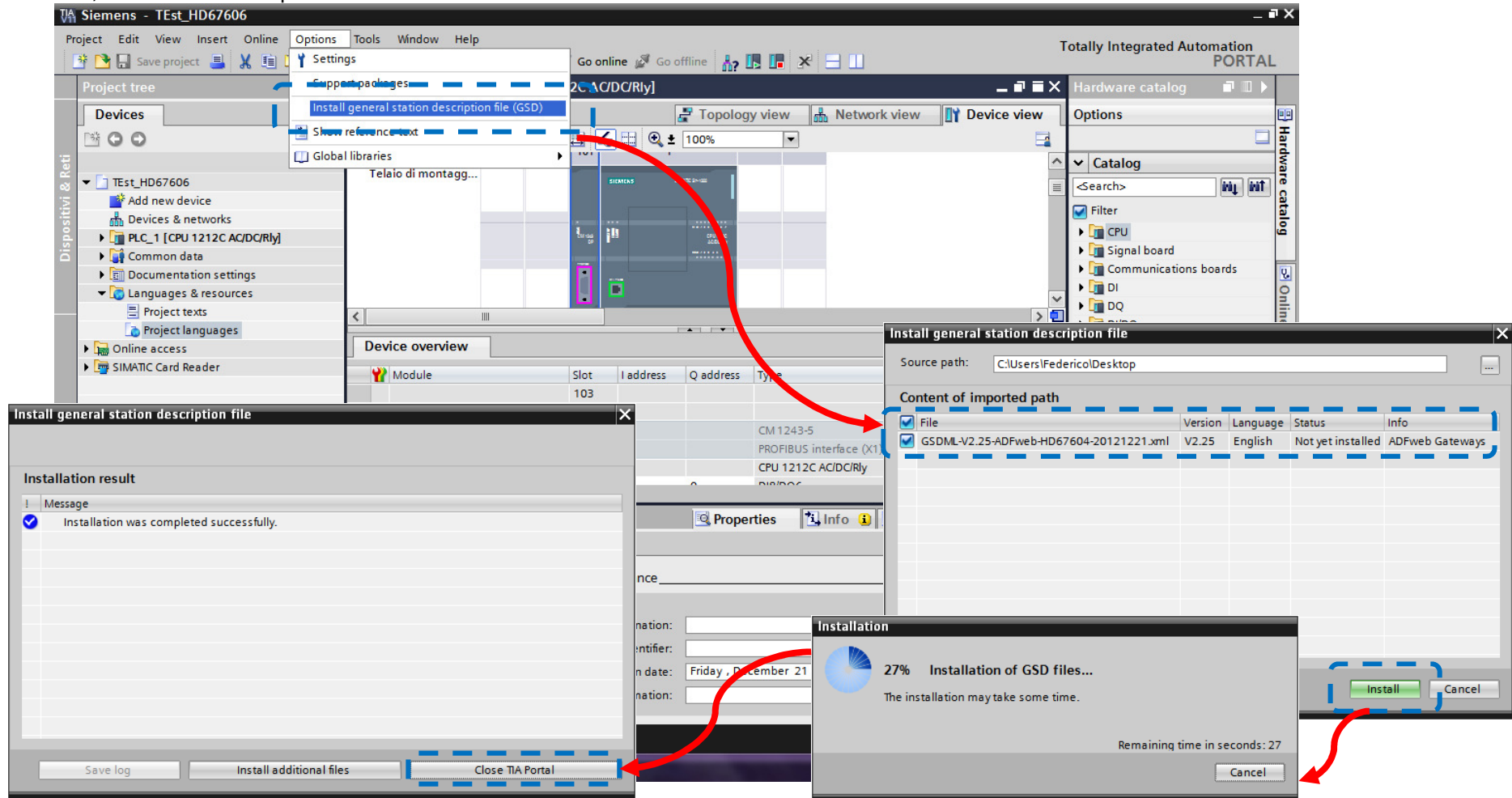

The screenshot illustrates the process of installing a GSD file in Siemens TIA Portal V11. The main interface shows the 'Install general station description file' dialog box. The 'Source path' is set to 'C:\Users\Federico\Desktop'. The 'Content of imported path' table is as follows:

File	Version	Language	Status	Info
<input checked="" type="checkbox"/>	V2.25	English	Not yet installed	ADFweb Gateways

The 'Install' button is highlighted with a red dashed box. A progress dialog shows '27% Installation of GSD files...' and 'Remaining time in seconds: 27'. A message dialog indicates 'Installation was completed successfully.' and the 'Close TIA Portal' button is highlighted with a red dashed box.

- 2) Press the **"Devices and networks"** button (1), from the right drop-down menu, under "Other field devices→PROFIBUS IO→Gateway→ ADFweb →HD67651" double click on "Serial" module (2).



Note:

If you have installed more than one **.xml** file, go to the Information section and in the "Version" field select the correct **.xml** file (3), before double clicking on "Serial" module

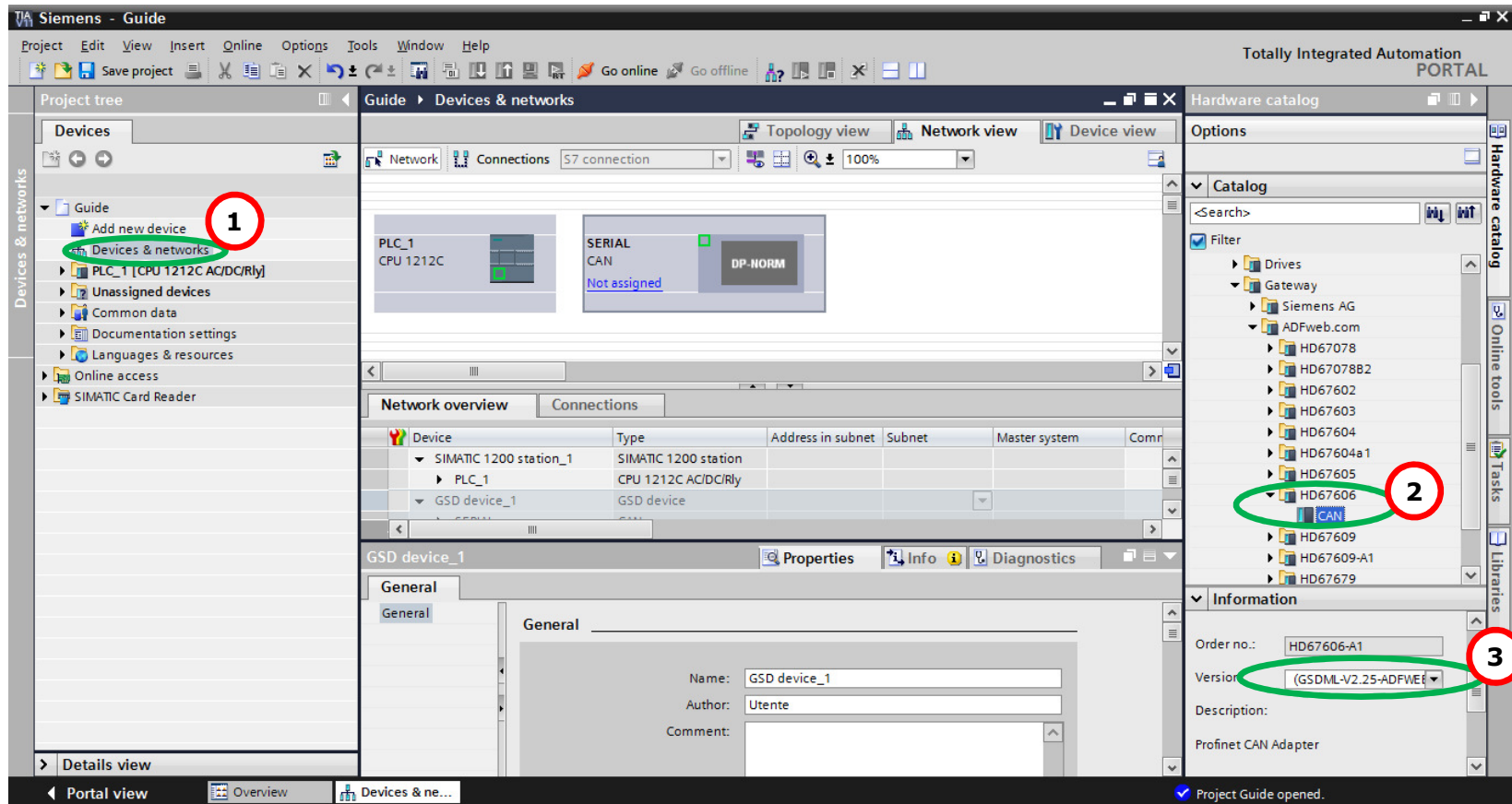

The screenshot shows the Siemens Guide software interface. The Project tree on the left has a red circle with the number 1 around the "Devices & networks" button. The Hardware catalog on the right has a red circle with the number 2 around the "CAN" module under the "HD67606" folder. The "Information" section at the bottom right has a red circle with the number 3 around the "Version" dropdown menu, which is set to "(GSDML-V2.25-ADFWE)".

Device	Type	Address in subnet	Subnet	Master system	Comr
▼ SIMATIC 1200 station_1	SIMATIC 1200 station				
▶ PLC_1	CPU 1212C AC/DC/Rly				
▼ GSD device_1	GSD device				

3) Connect the PLC to the CNV510-PBUS-RTU-A module by drawing the wire between the two Profibus ports (1)

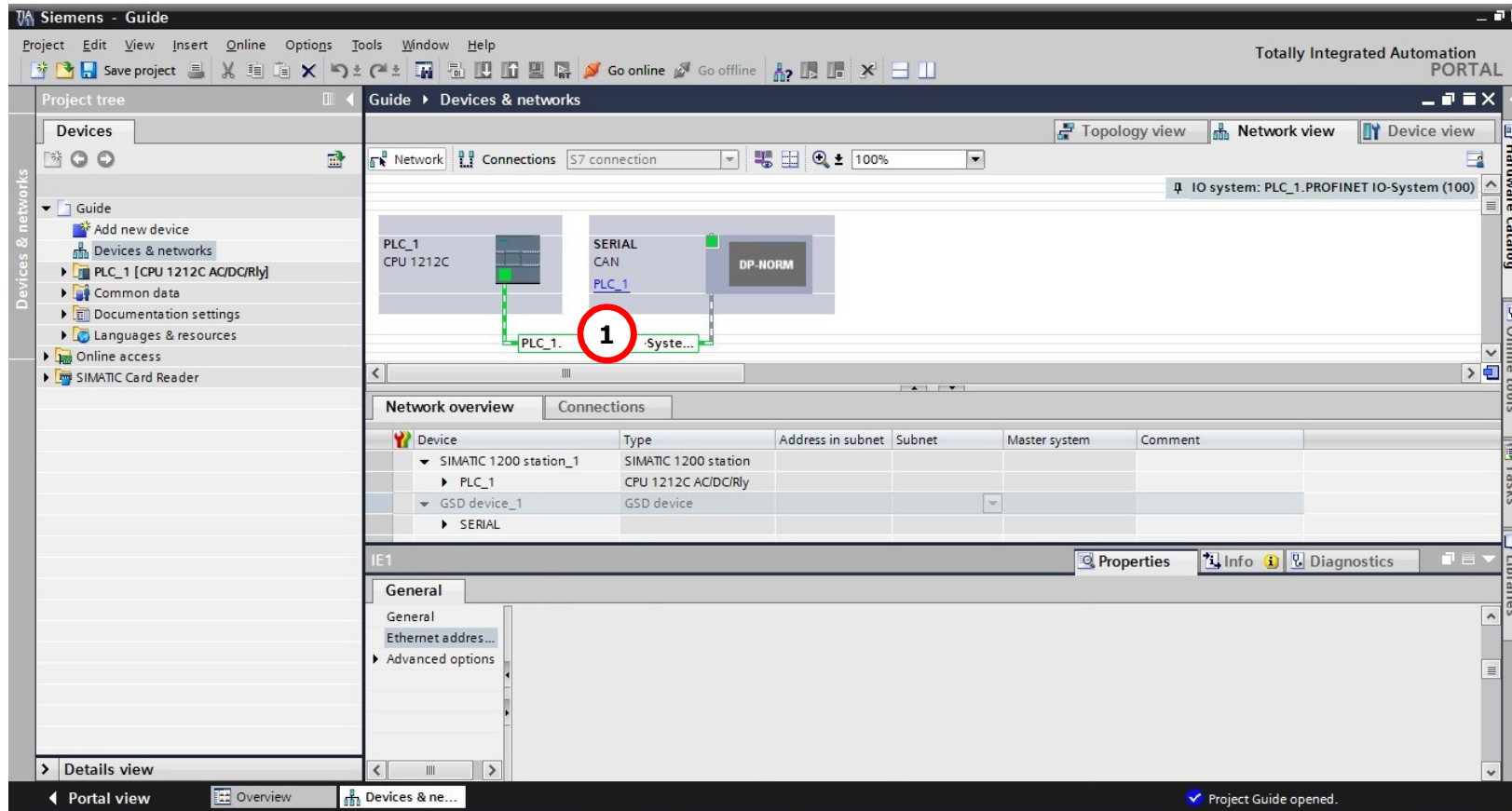

The screenshot shows the Siemens SIMATIC Manager interface. The main window displays a network diagram with the following components:

- PLC_1 CPU 1212C
- SERIAL CAN PLC_1
- DP-NORM

A red circle with the number '1' highlights a connection line between the PLC_1 and SERIAL CAN ports.

The 'Network overview' table is as follows:

Device	Type	Address in subnet	Subnet	Master system	Comment
<ul style="list-style-type: none"> SIMATIC 1200 station_1 <ul style="list-style-type: none"> PLC_1 	SIMATIC 1200 station				
<ul style="list-style-type: none"> GSD device_1 <ul style="list-style-type: none"> SERIAL 	GSD device				

The 'Details view' at the bottom shows the 'General' tab for the selected device, with 'Ethernet address...' selected.

4) Then double click on the "Serial" label (1) and in the field name change it accordingly to the name defined in the Compositor_SW67651 (2).

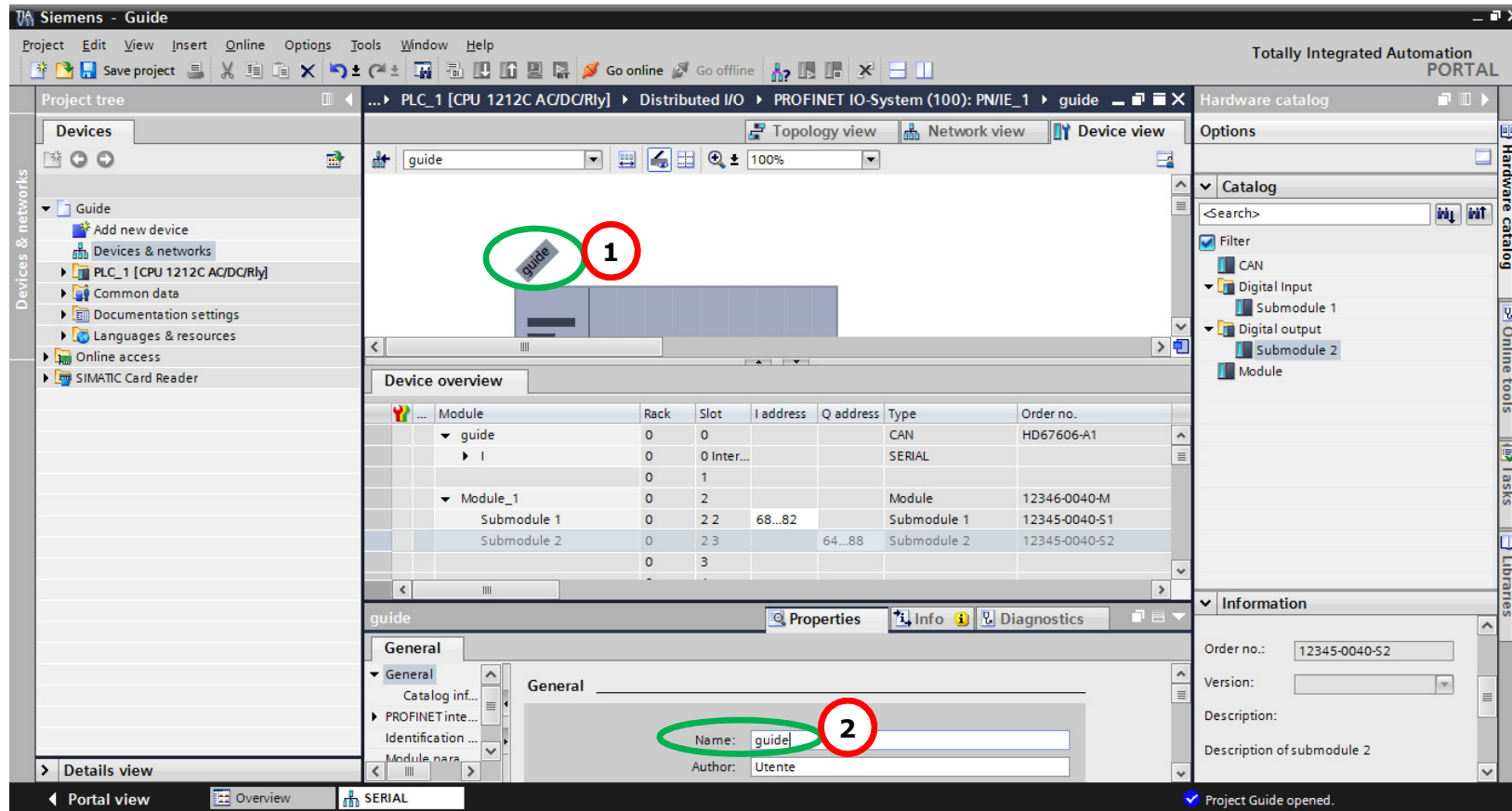

The screenshot shows the Siemens SIMATIC Manager interface. The main workspace displays a rack configuration with a CAN module (guide) and a SERIAL module. The SERIAL module is highlighted with a red circle labeled '1'. Below the workspace, the 'Device overview' table is visible:

Module	Rack	Slot	I address	Q address	Type	Order no.
guide	0	0			CAN	HD67606-A1
└─ I	0	0	Inter...		SERIAL	
└─ 1	0	1				
Module_1	0	2			Module	12346-0040-M
└─ Submodule 1	0	2	68...82		Submodule 1	12345-0040-S1
└─ Submodule 2	0	2	3	64...88	Submodule 2	12345-0040-S2
└─ 3	0	3				

The 'Properties' window for the 'guide' module is open, showing the 'General' tab. The 'Name' field is circled in green and labeled '2', with the value 'guidel' entered. The 'Author' field contains 'Utente'.

5) Load the configuration into the PLC.

Extended download to device

Configured access nodes of "PLC_1"

Device	Device type	Type	Address	Subnet
PLC_1	CPU 1212C AC/D...	PN/IE	192.168.2.50	PN/IE_1
CM 1243-5	CM 1243-5	PROFIBUS	2	

Type of the PG/PC interface:

PG/PC interface:

Connection to subnet:

1st gateway:

Accessible devices in target subnet: Show all accessible devices

Device	Device type	Type	Address	Target device
PLC_1	CPU 1212C AC/D...	PN/IE	192.168.2.50	PLC_1
--	--	PN/IE	Access address	--

Flash LED

Refresh

Online status information:

- Connected to address 192.168.2.50
- Scanning ended.

Load Cancel

Load preview

Check before loading

Status	!	Target	Message	Action
↓↑	✓	PLC_1	Ready for loading.	
	✓	▶ Stop modules	All modules will be stopped for downloading to device.	Stop all
	✓	▶ Device configurati...	Delete and replace system data in target	Download to device
	✓	▶ Software	Download software to device	Consistent download
	✓	▶ Additional inform...	There are differences between the settings for the project and the se	<input checked="" type="checkbox"/> Overwrite all

Refresh

Finish Load Cancel

DISCLAIMER:

All technical content within this document can be modified without notice. The content of the document is under continual renewal. For losses due to fire, earthquake, third party access or other accidents, or intentional or accidental abuse, misuse, or use under abnormal conditions repairs are charged to the user. Pixsys srl will not be liable for accidental loss of use or inability to use this product, such as loss of business income. Pixsys srl shall not be liable for consequences of improper use.

OTHER REGULATIONS AND STANDARDS:

WEEE INFORMATION



Disposal of old electrical and electronic equipment (as in the European Union and other European countries with separate collection systems).

This symbol on the product or on its packaging indicates that this product may not be treated as household rubbish. Instead, it should be taken to an applicable collection point for the recycling of electrical and electronic equipment. If the product is disposed correctly, you will help prevent potential negative environmental factors and impact of human health, which could otherwise be caused by inappropriate disposal. The recycling of materials will help to conserve natural resources. For more information about recycling this product, please contact your local city office, your household waste disposal service or the shop where you purchased the product.

RESTRICTION OF HAZARDOUS SUBSTANCES DIRECTIVE



The device respects the 2002/95/EC Directive on the restriction of the use of certain hazardous substances in electrical and electronic equipment (commonly referred to as Restriction of Hazardous Substances Directive or RoHS).

CE MARKING



The product conforms with the essential requirements of the applicable EC directives.



WARRANTIES AND TECHNICAL SUPPORT:

For fast and easy technical support for your Pixsys products, consult our internet Forum at <https://forum.pixsys.net>
Otherwise contact us at the address support@pixsys.net

RETURN POLICY:

If while using your product you have any problem and you wish to exchange or repair it, please do the following:

- Obtain a Product Return Authorization (RMA) from our internet page, in the "Il mio dispositivo / My device" section at www.pixsys.net Together with the request, you need to provide detailed information about the problem.
- Send the product to the address provided with the RMA, having prepaid the shipping costs (shipment costs billed to us will not be accepted).

If the product is within the warranty of 12 months, it will be repaired or exchanged and returned within four weeks. If the product is no longer under warranty, you will receive a repair estimate.



PIXSYS srl

www.pixsys.net

sales@pixsys.net - support@pixsys.net

online assistance: <http://forum.pixsys.net>

2300.10.294
080419